

FAG

Shock Absorbers

Strut Assembly | Strut Top Mount | Rear Shock Absorber

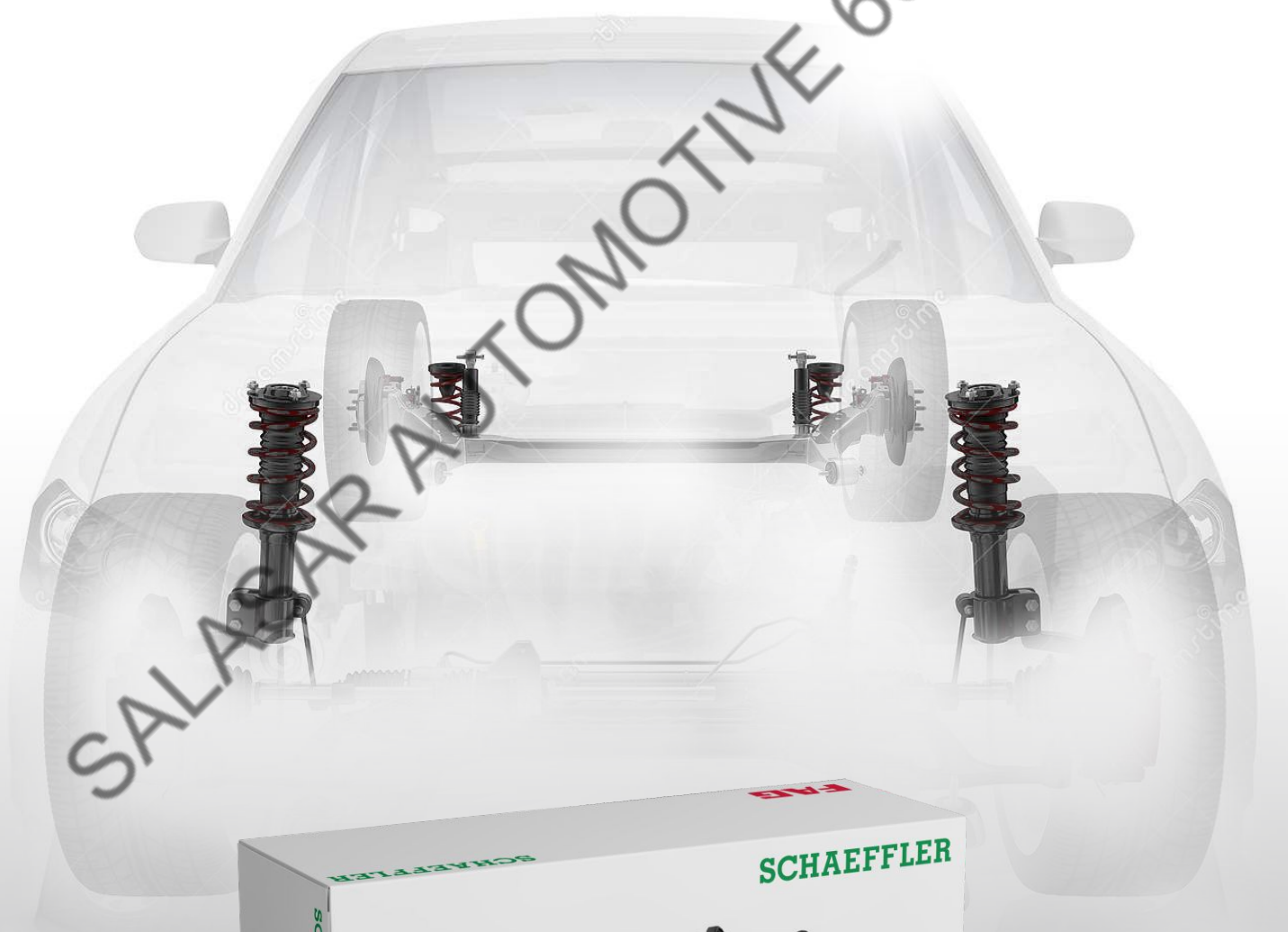



TRANSMISSION SYSTEMS



ENGINE SYSTEMS



CHASSIS SYSTEMS

Intelligent & Professional Repair Solution

- Under the three brands LuK, INA and FAG we offer clutch and release systems, engine and transmission applications, as well as chassis applications.
- Comprehensive portfolio in original-equipment (OE) quality.
- All components are tuned to work together perfectly for a simple, quick and professional repair.

www.schaeffler-aftermarket.in



FAG - The Chassis Specialist: Leading in quality, repair solution and future technology

SCHAEFFLER



Strong FAG Brand:

FAG is a well known and respected brand with a rich history of over 120 years in chassis system expertise and as a wheel bearing manufacturer. Technical innovations like Active Roll Stabilizer and Ride Height Adjustment underline Schaeffler's commitment to future chassis developments.

Complete repair solutions:

FAG repair solutions are tailored towards today's garage requirements when it comes to safe and efficient repairs. They contain all necessary parts to carry out professional repairs including all required accessories with market leading quality throughout the entire range.

Comprehensive quality promise:

FAG offers constant high quality components throughout the entire range by using durability and performance enhancing coating and sealing technologies like zinc flake coating and TPU boot material. Every single part is designed and tested according to Schaeffler quality standards.

Relevant range:

FAG developed a customer oriented range of chassis components and intelligent repair solutions for the most relevant applications of the European car park.

Steering & Suspension



Shock Absorbers



Wheel bearings & Modules



FAG Shock Absorber :

Built for performance and durability

SCHAEFFLER

Thrust bearing:

Designed for Low starting torque to ensure smooth steering and high load carrying capacity for long life

Piston Rod:

Produced through world class **Dyno Chrome Technology** for uniform thickness and for smooth operation for long life

Outer Tube:

High-tech surface coating, less corrosion and long durability

Banded pistons:

Multi-tuning valving technology supports for consistent damping force and different damping forces at different velocity

Nuts and bolts:

SAE Standard grade

Bump stop:

Protect vehicle from road impact and prevents other components impact damages for smoother driving

Coil spring:

High quality resilience spring for smooth and long lasting performance

Coil Spring isolator:

Protect metal to metal contact and reduce noise level

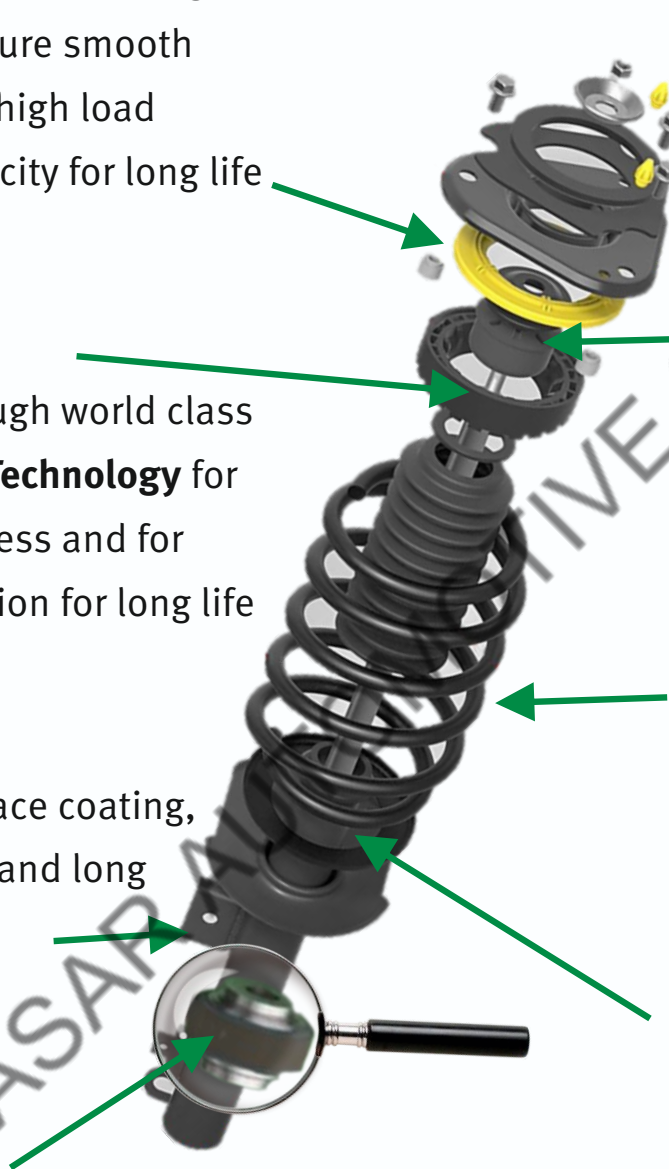

Index

ASHOK LEYLAND



CHEVROLET



FORD



HONDA



HYUNDAI



MAHINDRA



MARUTI SUZUKI



NISSAN



RENAULT



TATA



TEMPO TRAVELLER



TOYOTA



VOLKSWAGEN



ASHOK LEYLAND

MODELS

ASHOK LEYLAND DOST
(2011-2014) DIESEL



ASHOK LEYLAND DOST RIGID AXLE
(2014-2021) DIESEL



SALASAR AUTOMOTIVE 6002547900



Ashok Leyland Dost (2011-2014) Diesel



Schaeffler Part No.	Product Description and Position	Shock Absorber Type	MOQ	List	MRP	Picture
8090044100#E	Shock Assy. FRH/FLH	Oil	12	912	1,183	
8090045100#E	Shock Assy. RLH/RRH	Damper - Oil	12	912	1,183	

SALASAR AUTOMOTIVE 6002847300



Ashok Leyland Dost Rigid Axle (2014-2021) Diesel



Schaeffler Part No.	Product Description and Position	Shock Absorber Type	MOQ	List	MRP	Picture
8090046100#E	Shock Assy. FRH/FLH	Oil	12	745	966	
8090047100#E	Shock Assy. RLH/RRH	Damper - Oil	12	721	935	

SALASAR AUTOMOTIVE 6002847300



CHEVROLET

MODELS

CHEVROLET BEAT
(2010-2017) PETROL/DIESEL 

SALASAR AUTOMOTIVE 6002847900



Chevrolet Beat (2010-2017) Petrol/Diesel



Schaeffler Part No.	Product Description and Position	Shock Absorber Type	MOQ	List	MRP	Picture
8090005100#E	Rear Shock LH/RH	Damper - Gas	6	1,186	1,423	
8090006100#E	Strut Assy. (FRH)	Full Assembly - Gas	2	3,714	4,457	
8090007100#E	Strut Assy. (FLH)	Full Assembly - Gas	2	3,714	4,457	
8090196100#E	Element (FRH)	Damper - Gas	4	1,768	2,293	
8090197100#E	Element (FLH)	Damper - Gas	4	1,768	2,293	



FORD

MODELS

FORD ECOSPORT
(2013-NOW) PETROL/DIESEL



FORD FIESTA
(2012-2015) PETROL/DIESEL



FORD FIGO
(2010-2015) PETROL/DIESEL



FORD FIGO/FIESTA
(2010-2015) PETROL/DIESEL



SALASAR AUTOMOTIVE 800-254-7900



Ford Ecosport (2013-Now) Petrol/Diesel



Schaeffler Part No.	Product Description and Position	Shock Absorber Type	MOQ	List	MRP	Picture
8090024100#E	Shock Assy. RLH/RRH	Damper - Gas	4	1,783	2,313	
8090025100#E	Element (FLH)	Damper - Gas	4	2,362	3,064	
8090026100#E	Element (FRH)	Damper - Gas	4	2,362	3,064	



Ford Fiesta (2012-2015) Petrol/Diesel



Schaeffler Part No.	Product Description and Position	Shock Absorber Type	MOQ	List	MRP	Picture
8090027100#E	Rear Shock LH/RH	Damper - Gas	6	1,207	1,565	

SALASAR AUTOMOTIVE 6002847900



Ford Figo (2010-2015) Petrol/Diesel







Schaeffler Part No.	Product Description and Position	Shock Absorber Type	MOQ	List	MRP	Picture
8090028100#E	Rear Shock LH/RH	Damper - Gas	6	1,146	1,486	

SALASAR AUTOMOTIVE 6002847900

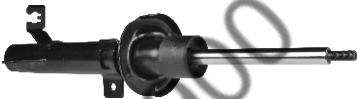

Ford Figo/Fiesta (2010-2015) Petrol/Diesel



Schaeffler Part No.	Product Description and Position	Shock Absorber Type	MOQ	List	MRP	Picture
8090208100#E	Element (FRH)	Damper - Gas	4	1,714	2,232	
8090207100#E	Element (FLH)	Damper - Gas	4	1,714	2,232	
8090050100#E	Strut Assy. (FRH)	Full Assembly-Gas	2	3,553	4,608	
8090051100#E	Strut Assy. (FLH)	Full Assembly-Gas	2	3,553	4,608	

SALASAR AUTOMOTIVE 6002847900



HONDA

MODELS

HONDA AMAZE
(2013-2016) PETROL/DIESEL



HONDA AMAZE
(2013-2018) PETROL/DIESEL



HONDA CITY TYPE III & IV
(2003-2009) PETROL



HONDA CITY TYPE IV
(2003-2009) PETROL



HONDA CITY TYPE V
(2009-2013) PETROL



SALASAR AUTOMOTIVE 5002547900



Honda Amaze (2013-2016) Petrol/Diesel



Schaeffler Part No.	Product Description and Position	Shock Absorber Type	MOQ	List	MRP	Picture
8090001100#E	Element (FRH)	Full Assembly - Gas		Introducing Soon		
8090002100#E	Element (FLH)	Full Assembly - Gas		Introducing Soon		
8090003100#E	Strut Assy. (FRH)	Full Assembly - Gas	4	3,571	4,285	
8090004100#E	Strut Assy. (FLH)	Full Assembly - Gas	4	3,571	4,285	

SALASAR AUTOMOTIVE 6002847300



Honda Amaze (2013-2018) Petrol/Diesel



Schaeffler Part No.	Product Description and Position	Shock Absorber Type	MOQ	List	MRP	Picture
8090183100#E	Rear Shock LH/RH	Damper - Gas	6	1,455	1,887	

SALASAR AUTOMOTIVE 6002847900



Honda City Type III & IV (2003-2009) Petrol





Schaeffler Part No.	Product Description and Position	Shock Absorber Type	MOQ	List	MRP	Picture
8090185100#E	Rear Shock LH/RH	Damper - Gas	6	1,771	2,297	

SALASAR AUTOMOTIVE 6002847900



Honda City Type IV (2003-2009) Petrol





Schaeffler Part No.	Product Description and Position	Shock Absorber Type	MOQ	List	MRP	Picture
8090194100#E	Element (FRH)	Damper - Gas	4	1,933	2,507	
8090195100#E	Element (FLH)	Damper - Gas	4	1,933	2,507	

SALASAR AUTOMOTIVE 6002847900



Honda City Type V (2009-2013) Petrol



Schaeffler Part No.	Product Description and Position	Shock Absorber Type	MOQ	List	MRP	Picture
8090192100#E	Element (FRH)	Damper - Gas	4	1,942	2,519	
8090193100#E	Element (FLH)	Damper - Gas	4	1,942	2,519	
8090184100#E	Rear Shock LH/RH	Damper - Gas	6	1,702	2,207	

SALASAR AUTOMOTIVE 6002847900



HYUNDAI

MODELS

HYUNDAI ACCENT
(1999-2008) PETROL/DIESEL



HYUNDAI ACCENT
(1999-2008) PETROL



HYUNDAI ACCENT CRDi
(2002-2007) DIESEL



HYUNDAI CRETA
(2015-2018) PETROL/DIESEL



HYUNDAI EON
(2011-NOW) PETROL



HYUNDAI FLUDIC VERNA
(2011-2014) PETROL/DIESEL



HYUNDAI GRAND i10/XCENT
(2013-2016) PETROL/DIESEL



HYUNDAI i10
(2007-2013) PETROL



HYUNDAI i20
(2008-2012) PETROL/DIESEL



HYUNDAI i20 ELITE
(2014-2020) PETROL/DIESEL



HYUNDAI SANTRO
(1998-2003) PETROL



HYUNDAI SANTRO
(1998 - 2014) PETROL



HYUNDAI VERNA
(2007-2011) PETROL/DIESEL



Hyundai Accent (1999-2008) Petrol/Diesel





Schaeffler Part No.	Product Description and Position	Shock Absorber Type	MOQ	List	MRP	Picture
8090120100#E	Element (FRH)	Damper - Oil			Introducing Soon	
8090121100#E	Element (FLH)	Damper - Oil			Introducing Soon	
8090124100#E	Rear Shock RH	Damper - Gas			Introducing Soon	
8090125100#E	Rear Shock LH	Damper - Gas			Introducing Soon	

SALASAR AUTOMOTIVE 600284790



Hyundai Accent (1999-2008) Petrol





Schaeffler Part No.	Product Description and Position	Shock Absorber Type	MOQ	List	MRP	Picture
8090122100#E	Strut Assy. (FRH)	Full Assembly - Oil				
8090123100#E	Strut Assy. (FLH)	Full Assembly - Oil				

SALASAR AUTOMOTIVE 6002847100



Hyundai Accent CRDi (2002-2007) Diesel



Schaeffler Part No.	Product Description and Position	Shock Absorber Type	MOQ	List	MRP	Picture
8090152100#E	Element (FLH)	Damper - Gas				
8090153100#E	Element (FRH)	Damper - Gas				

SALASAR AUTOMOTIVE 6002847100



Hyundai Creta (2015-2018) Petrol/Diesel





Schaeffler Part No.	Product Description and Position	Shock Absorber Type	MOQ	List	MRP	Picture
8090158100#E	Rear Shock LH/RH	Damper - Gas			Introducing Soon	

SALASAR AUTOMOTIVE 6002847900



Hyundai Eon (2011-Now) Petrol





Schaeffler Part No.	Product Description and Position	Shock Absorber Type	MOQ	List	MRP	Picture
8090131100#E	Element (FLH/FRH)	Damper - Gas	4	1,524	1,977	
8090159100#E	Shock Assy. RLH/RRH	Damper - Gas	12	980	1,271	

SALASAR AUTOMOTIVE 6002847900



Hyundai Fluidic Verna (2011-2014) Petrol/Diesel



Schaeffler Part No.	Product Description and Position	Shock Absorber Type	MOQ	List	MRP	Picture
8090149100#E	Shock Assy. RLH/RRH	Damper - Gas	6	1,622	2,104	
8090150100#E	Element (FLH)	Damper - Gas	Introducing Soon			
8090151100#E	Element (FRH)	Damper - Gas	Introducing Soon			

SALASAR AUTOMOTIVE 600224790



Hyundai Grand i10/Xcent (2013-2016) Petrol/Diesel



Schaeffler Part No.	Product Description and Position	Shock Absorber Type	MOQ	List	MRP	Picture
8090160100#E	Rear Shock LH/RH	Damper - Gas	6	1,743	2,092	

SALASAR AUTOMOTIVE 6002847900



Hyundai i10 (2007-2013) Petrol



Schaeffler Part No.	Product Description and Position	Shock Absorber Type	MOQ	List	MRP	Picture
8090128100#E	Element (FRH)	Damper - Gas	4	1,300	1,686	
8090129100#E	Element (FLH)	Damper - Gas	4	1,300	1,686	
8090130100#E	Shock Assy. RLH/RRH	Damper - Gas	6	1,363	1,768	

SALASAR AUTOMOTIVE 6002841300



Hyundai i20 (2008-2012) Petrol/Diesel





Schaeffler Part No.	Product Description and Position	Shock Absorber Type	MOQ	List	MRP	Picture
8090154100#E	Shock Assy. RLH/RRH	Damper - Gas	6	1,576	2,044	
8090155100#E	Element (FLH)	Damper - Gas	4	1,902	2,467	
8090156100#E	Element (FRH)	Damper - Gas	4	1,902	2,467	

SALASAR AUTOMOTIVE 6002847980



Hyundai i20 Elite (2014-2020) Petrol/Diesel



Schaeffler Part No.	Product Description and Position	Shock Absorber Type	MOQ	List	MRP	Picture
8090126100#E	Element (FRH)	Damper - Gas	4	1,818	2,358	
8090127100#E	Element (FLH)	Damper - Gas	4	1,818	2,358	
8090157100#E	Rear Shock LH/RH	Damper - Gas	6	1,339	1,737	

SALASAR AUTOMOTIVE 600247980



Hyundai Santro (1998-2003) Petrol



Schaeffler Part No.	Product Description and Position	Shock Absorber Type	MOQ	List	MRP	Picture
8090132100#E	Element (FRH)	Damper - Gas	4	1,557	2,019	
8090133100#E	Element (FLH)	Damper - Gas	4	1,557	2,019	
8090134100#E	Strut Assy. (FRH)	Full Assembly - Gas		Introducing Soon		
8090135100#E	Strut Assy. (FLH)	Full Assembly - Gas		Introducing Soon		
8090136100#E	Element (FRH)	Damper - Oil		Introducing Soon		
8090137100#E	Element (FLH)	Damper - Oil		Introducing Soon		



Hyundai Santro (1998 - 2014) Petrol





Schaeffler Part No.	Product Description and Position	Shock Absorber Type	MOQ	List	MRP	Picture
8090161100#E	Shock Assy. RLH/RRH	Damper - Gas	12	666	864	

SALASAR AUTOMOTIVE 6002847900



Hyundai Verna (2007-2011) Petrol/Diesel



Schaeffler Part No.	Product Description and Position	Shock Absorber Type	MOQ	List	MRP	Picture
8090117100#E	Rear Shock LH/RH	Damper - Gas	6	1,512	1,961	
8090118100#E	Element (FRH)	Damper - Gas	Introducing Soon			
8090119100#E	Element (FLH)	Damper - Gas	Introducing Soon			

SALASAR AUTOMOTIVE 6002847900



MAHINDRA

MODELS

MAHINDRA BOLERO
(2004-2020) DIESEL



MAHINDRA BOLERO PICKUP
(2010-2019) DIESEL



MAHINDRA JEEP TAXI
(2000-2008) DIESEL



MAHINDRA LOGAN
(2007-2018) DIESEL



MAHINDRA MAXIMO 0.9TON
(2013-2021) DIESEL



MAHINDRA MAXIMO 1TON
(2011-NOW) DIESEL



MAHINDRA-SCORPIO MULTILINK
(2006-2008) DIESEL



MAHINDRA SCORPIO
(2002-2006) PETROL/DIESEL



MAHINDRA XUV 500
(2011-2015) DIESEL



MAHINDRA XYLO - E9
(2012-2019) DIESEL



MAHINDRA XYLO
(2009-2012) DIESEL



MAHINDRA XYLO
(2009-2014) DIESEL





MAHINDRA XYLO PICKUP
(2011-2016) DIESEL



Mahindra Bolero (2004-2020) Diesel





Schaeffler Part No.	Product Description and Position	Shock Absorber Type	MOQ	List	MRP	Picture
8090162100#E	Shock Assy. FRH/FLH	Oil	12	881	1,143	
8090163100#E	Shock Assy. RLH/RRH	Damper - Oil	12	629	816	

SALASAR AUTOMOTIVE 6002847900



Mahindra Bolero Pickup (2010-2019) Diesel



Schaeffler Part No.	Product Description and Position	Shock Absorber Type	MOQ	List	MRP	Picture
8090164100#E	Shock Assy. FRH/FLH	Oil	12	856	1,110	
8090165100#E	Shock Assy. RLH/RRH	Damper - Oil	12	879	1,140	

SALASAR AUTOMOTIVE 600284790



Mahindra JeepTaxi (2000-2008) Diesel





Schaeffler Part No.	Product Description and Position	Shock Absorber Type	MOQ	List	MRP	Picture
8090180100#E	Shock Assy. RLH/RRH	Oil	12	507	608	

SALASAR AUTOMOTIVE 6002847900



Mahindra Logan (2007-2018) Diesel





Schaeffler Part No.	Product Description and Position	Shock Absorber Type	MOQ	List	MRP	Picture
8090172100#E	Element (FLH/FRH)	Damper - Gas				
8090173100#E	Shock Assy. RLH/RRH	Damper - Gas				

SALASAR AUTOMOTIVE 6002847900



Mahindra Maximo 0.9Ton (2013-2021) Diesel





Schaeffler Part No.	Product Description and Position	Shock Absorber Type	MOQ	List	MRP	Picture
8090166100#E	Element (FLH/FRH)	Damper - Gas	4	1,653	2,144	
8090186100#E	Rear Shock LH/RH	Damper - Oil	12	912	1,183	

SALASAR AUTOMOTIVE 6002847680



Mahindra Maximo 1Ton (2011-Now) Diesel





Schaeffler Part No.	Product Description and Position	Shock Absorber Type	MOQ	List	MRP	Picture
8090167100#E	Element (FLH/FRH)	Damper - Gas	4	2,165	2,808	
8090187100#E	Rear Shock LH/RH	Damper - Oil	12	875	1,135	

SALASAR AUTOMOTIVE 600284700



Mahindra-Scorpio Multilink (2006-2008) Diesel





Schaeffler Part No.	Product Description and Position	Shock Absorber Type	MOQ	List	MRP	Picture
8090168100#E	Element (FLH/FRH)	Oil	12	867	1,124	
8090169100#E	Shock Assy. RLH/RRH	Damper - Oil	12	835	1,083	



SALASAR AUTOMOTIVE 6002847900

Mahindra Scorpio (2002-2006) Petrol/Diesel





Schaeffler Part No.	Product Description and Position	Shock Absorber Type	MOQ	List	MRP	Picture
8090170100#E	Shock Assy. RLH/RRH	Oil	12	732	949	
8090171100#E	Shock Assy. RLH/RRH	Damper - Oil	12	834	1,082	

SALASAR AUTOMOTIVE 6002847380



Mahindra XUV 500 (2011-2015) Diesel



Schaeffler Part No.	Product Description and Position	Shock Absorber Type	MOQ	List	MRP	Picture
8090138100#E	Rear Shock LH/RH	Damper - Gas	4	1,980	2,568	
8090139100#E	Element (FRH)	Damper - Gas	4	2,905	3,768	
8090140100#E	Element (FLH)	Damper - Gas	4	2,905	3,768	

SALASAR AUTOMOTIVE 6002847900



Mahindra Xylo - E9 (2012-2019) Diesel



Schaeffler Part No.	Product Description and Position	Shock Absorber Type	MOQ	List	MRP	Picture
8090174100#E	Shock Assy. RLH/RRH	Damper - Gas	6	1,504	1,951	
8090175100#E	Element-ABS(FRH/FLH)	Damper - Gas	4	1,969	2,554	

SALASAR AUTOMOTIVE 6002847900



Mahindra Xylo (2009-2012) Diesel





Schaeffler Part No.	Product Description and Position	Shock Absorber Type	MOQ	List	MRP	Picture
8090177100#E	Shock Assy. RLH/RRH	Damper - Gas	6	1,075	1,394	

SALASAR AUTOMOTIVE 6002847900



Mahindra Xylo (2009-2014) Diesel



Schaeffler Part No.	Product Description and Position	Shock Absorber Type	MOQ	List	MRP	Picture
8090178100#E	Element (FLH/FRH)	Damper - Gas	4	1,243	1,612	
8090179100#E	Strut Assy. FRH/FLH	Full Assembly - Gas	Introducing Soon			

SALASAR AUTOMOTIVE 6002847900



Mahindra Xylo Pickup (2011-2016) Diesel



Schaeffler Part No.	Product Description and Position	Shock Absorber Type	MOQ	List	MRP	Picture
8090176100#E	Element (FLH/FRH)	Damper - Gas			Introducing Soon	

SALASAR AUTOMOTIVE 6002847900



MARUTI

MODELS

MARUTI SUZUKI 800 DX
(1986-2014) PETROL



MARUTI SUZUKI 800
(2005-2014) PETROL



MARUTI SUZUKI 800 DX
(1997-2005) PETROL



MARUTI SUZUKI ALTO
(2000-2014) PETROL



MARUTI SUZUKI ALTO/ALTO K10/800
(2000-2005) PETROL



MARUTI SUZUKI ALTO/ALTO K10/
NEW K10/800 (2010-NOW) PETROL



MARUTI SUZUKI NEW BALENO
(2015-2019) PETROL



MARUTI SUZUKI NEW BALENO
(2015-2019) PETROL/DIESEL



MARUTI SUZUKI CELERIO (2013-2017) PETROL/DIESEL



MARUTI SUZUKI CELERIO
(2013-NOW) PETROL/DIESEL



MARUTI SUZUKI CIAZ
(2014-NOW) PETROL/DIESEL



MARUTI SUZUKI ECO
(2010-2019) PETROL



MARUTI SUZUKI ECO TYPE-I
(2010-2019) PETROL



MARUTI SUZUKI ECO TYPE-II
(2010-2019) PETROL



MARUTI SUZUKI ERTIGA
(2012-2018) DIESEL



MARUTI SUZUKI ERTIGA
(2012-2018) PETROL/DIESEL



-----MORE MODELS-----

MARUTI

MODELS

MARUTI SUZUKI OMNI
(1996-2002) PETROL



MARUTI SUZUKI OMNI TYPE-III
(1996-2002) PETROL



MARUTI SUZUKI RITZ
(2009-2016) DIESEL



MARUTI SUZUKI RITZ
(2009-2016) PETROL/DIESEL



MARUTI SUZUKI SWIFT
(2005-2011) DIESEL



MARUTI SUZUKI NEW SWIFT
(2011-2017) DIESEL



MARUTI SUZUKI SWIFT
(2005-2011) PETROL/DIESEL



MARUTI SUZUKI SWIFT
(2011-17) PETROL/DIESEL



MARUTI SUZUKI NEW SWIFT &
SWIFT DZIRE (2017-NOW) DIESEL



MARUTI SUZUKI WAGON-R
(2000-2006) PETROL



MARUTI SUZUKI WAGON-R TYPE-IV
(2010-2018) PETROL



MARUTI SUZUKI ZEN
(1996-2006) PETROL/DIESEL



MARUTI SUZUKI ZEN
(1996-2006) PETROL



-----PREVIOUS PAGE-----



Maruti Suzuki 800 DX (1986-2014) Petrol



Schaeffler Part No.	Product Description and Position	Shock Absorber Type	MOQ	List	MRP	Picture
8090100100#E	Strut Assy. (FRH)	Full Assembly - Oil	Introducing Soon			
8090101100#E	Strut Assy. (FLH)	Full Assembly - Oil	Introducing Soon			
8090116100#E	Shock Assy. RLH/RRH	Damper - Oil	12	469	563	
8090102100#E	Element-Bushkit FRH	Damper - Oil	Introducing Soon			
8090103100#E	Element-BushKit FLH	Damper - Oil	Introducing Soon			
8090104100#E	Element (FRH)	Damper - Oil	Introducing Soon			
8090105100#E	Element (FLH)	Damper - Oil	Introducing Soon			



Maruti Suzuki 800 (2005-2014) Petrol



Schaeffler Part No.	Product Description and Position	Shock Absorber Type	MOQ	List	MRP	Picture
8090147100#E	Shock Assy. RLH/RRH	Damper - Gas			Introducing Soon	

SALASAR AUTOMOTIVE 6002847900



Maruti Suzuki 800 DX (1997-2005) Petrol



Schaeffler Part No.	Product Description and Position	Shock Absorber Type	MOQ	List	MRP	Picture
8090146100#E	Shock Assy. RLH/RRH	Damper - Gas			Introducing Soon	

SALASAR AUTOMOTIVE 6002847900



Maruti Suzuki Alto (2000-2014) Petrol



Schaeffler Part No.	Product Description and Position	Shock Absorber Type	MOQ	List	MRP	Picture
8090181100#E	Strut Assy. (FRH)	Full Assembly - Oil	4	2,085	2,704	
8090182100#E	Strut Assy. (FLH)	Full Assembly - Oil	4	2,085	2,704	
8090090100#E	Element (FRH)	Damper - Oil	Introducing Soon			
8090091100#E	Element (FLH)	Damper - Oil	Introducing Soon			
8090092100#E	Element-Bushkit FRH	Damper - Oil	Introducing Soon			
8090093100#E	Element-BushKit FLH	Damper - Oil	Introducing Soon			
8090144100#E	Shock Assy. RLH/RRH	Damper - Gas	12	642	833	



Maruti Suzuki Alto/Alto K10/800 (2000-2005) Petrol



Schaeffler Part No.	Product Description and Position	Shock Absorber Type	MOQ	List	MRP	Picture
8090094100#E	Element (FRH)	Damper - Gas	4	1,343	1,742	
8090095100#E	Element (FLH)	Damper - Gas	4	1,343	1,742	
8090096100#E	Strut Assy. (FRH)	Full Assembly - Gas	4	2,086	2,503	
8090097100#E	Strut Assy. (FLH)	Full Assembly - Gas	4	2,086	2,503	
8090098100#E	Element-Bushkit FRH	Damper - Gas	Introducing Soon			
8090099100#E	Element-BushKit FLH	Damper - Gas	Introducing Soon			



Maruti Suzuki Alto/Alto K10/New K10/800) (2010-Now) Petrol





Schaeffler Part No.	Product Description and Position	Shock Absorber Type	MOQ	List	MRP	Picture
8090145100#E	Shock Assy. RLH/RRH	Damper - Gas	12	734	952	

SALASAR AUTOMOTIVE 6002847900



Maruti Suzuki New Baleno (2015-2019) Petrol



Schaeffler Part No.	Product Description and Position	Shock Absorber Type	MOQ	List	MRP	Picture
8090075100#E	Strut Assy. (FRH)	Full Assembly - Gas	4	3,416	4,431	
8090076100#E	Strut Assy. (FLH)	Full Assembly - Gas	4	3,416	4,431	

SALASAR AUTOMOTIVE 6002847300



Maruti Suzuki New Baleno (2015-2019) Petrol/Diesel





Schaeffler Part No.	Product Description and Position	Shock Absorber Type	MOQ	List	MRP	Picture
8090077100#E	Shock Assy. RLH/RRH	Damper - Gas	6	2,362	3,064	

SALASAR AUTOMOTIVE 6002847900



Maruti Suzuki Celerio (2013-2017) Petrol/Diesel



Schaeffler Part No.	Product Description and Position	Shock Absorber Type	MOQ	List	MRP	Picture
8090198100#E	Element (FRH)	Gas	4	1,743	2,261	
8090199100#E	Element (FLH)	Gas	4	1,743	2,261	

SALASAR AUTOMOTIVE 6002847900



Maruti Suzuki Celerio (2013-Now) Petrol/Diesel



Schaeffler Part No.	Product Description and Position	Shock Absorber Type	MOQ	List	MRP	Picture
8090112100#E	Shock Assy. RLH/RRH	Damper - Gas	6	1,642	2,130	

SALASAR AUTOMOTIVE 6002847900



Maruti Suzuki Ciaz (2014-Now) Petrol/Diesel



Schaeffler Part No.	Product Description and Position	Shock Absorber Type	MOQ	List	MRP	Picture
8090072100#E	Shock Assy. RLH/RRH	Damper - Gas	6	2,286	2,743	
8090073100#E	Element (FRH)	Damper - Gas	Introducing Soon			
8090074100#E	Element (FLH)	Damper - Gas	Introducing Soon			

SALASAR AUTOMOTIVE 6002847900



Maruti Suzuki Eco (2010-2019) Petrol





Schaeffler Part No.	Product Description and Position	Shock Absorber Type	MOQ	List	MRP	Picture
8090106100#E	Element (ABS)(FRH)	Damper - Oil	4	1,695	2,198	
8090107100#E	Element (ABS)(FLH)	Damper - Oil	4	1,695	2,198	
8090148100#E	Shock Assy. RLH/RRH	Damper - Oil	12	830	1,077	

SALASAR AUTOMOTIVE 6002847300



Maruti Suzuki Eco Type-I (2010-2019) Petrol





Schaeffler Part No.	Product Description Position	Shock Absorber Type	MOQ	List	MRP	Picture
8090110100#E	Strut Assy. (FRH)	Full Assembly - Oil	4	2,762	3,583	
8090111100#E	Strut Assy. (FLH)	Full Assembly - Oil	4	2,762	3,583	

SALASAR AUTOMOTIVE 600284730



Maruti Suzuki Eco Type-II (2010-2019) Petrol



Schaeffler Part No.	Product Description and Position	Shock Absorber Type	MOQ	List	MRP	Picture
8090108100#E	Strut Assy.ABS-FRH	Full Assembly - Oil	4	2,786	3,343	
8090109100#E	Strut Assy.ABS-FLH	Full Assembly - Oil	4	2,786	3,343	

SALASAR AUTOMOTIVE 6032847300



Maruti Suzuki Ertiga (2012-2018) Diesel



Schaeffler Part No.	Product Description and Position	Shock Absorber Type	MOQ	List	MRP	Picture
8090069100#E	Strut Assy. (FRH)	Full Assembly - Gas	4	3,949	5,122	
8090070100#E	Strut Assy. (FLH)	Full Assembly - Gas	4	3,949	5,122	
8090200100#E	Element (FRH)	Damper - Gas	4	1,806	2,340	
8090201100#E	Element (FLH)	Damper - Gas	4	1,806	2,340	



Maruti Suzuki Ertiga (2012-2018) Petrol/Diesel



Schaeffler Part No.	Product Description and Position	Shock Absorber Type	MOQ	List	MRP	Picture
8090071100#E	Shock Assy. RLH/RRH	Damper - Gas	6	1,831	2,375	

SALASAR AUTOMOTIVE 6002847900



Maruti Suzuki Omni (1996-2002) Petrol



Schaeffler Part No.	Product Description and Position	Shock Absorber Type	MOQ	List	MRP	Picture
8090115100#E	Shock Assy. RLH/RRH	Damper - Oil	12	447	580	

SALASAR AUTOMOTIVE 6002847900



Maruti Suzuki Omni Type-III (1996-2002) Petrol



Schaeffler Part No.	Product Description and Position	Shock Absorber Type	MOQ	List	MRP	Picture
8090113100#E	Element (FLH/FRH)	Damper - Oil	4	2,718	3,525	
8090114100#E	Element BushKit (FLH/FRH)	Damper - Oil	Introducing Soon			



SALASAR AUTOMOTIVE 600247980

Maruti Suzuki Ritz (2009-2016) Diesel





Schaeffler Part No.	Product Description and Position	Shock Absorber Type	MOQ	List	MRP	Picture
8090058100#E	Strut Assy. (FRH)	Full Assembly - Gas	4	3,118	4,044	
8090059100#E	Strut Assy. (FLH)	Full Assembly - Gas	4	3,118	4,044	
8090062100#E	Element-Bushkit FRH	Damper - Gas	Introducing Soon			
8090063100#E	Element-BushKit FLH	Damper - Gas	Introducing Soon			

SALASAR AUTOMOTIVE 60024790



Maruti Suzuki Ritz (2009-2016) Petrol/Diesel



Schaeffler Part No.	Product Description and Position	Shock Absorber Type	MOQ	List	MRP	Picture
8090057100#E	Shock Assy. RLH/RRH	Damper - Gas	12	1,416	1,837	
8090060100#E	Element (FRH)	Damper - Gas	4	1,691	2,193	
8090061100#E	Element (FLH)	Damper - Gas	4	1,691	2,193	

SALASAR AUTOMOTIVE 6002847900



Maruti Suzuki Swift (2005-2011) Diesel







Schaeffler Part No.	Product Description and Position	Shock Absorber Type	MOQ	List	MRP	Picture
8090053100#E	Strut Assy. (FRH)	Full Assembly - Gas	4	3,325	4,313	
8090054100#E	Strut Assy. (FLH)	Full Assembly - Gas	4	3,325	4,313	
8090055100#E	Element (FRH)	Damper - Gas	4	1,787	2,318	
8090056100#E	Element (FLH)	Damper - Gas	4	1,787	2,318	

SALASAR AUTOMOTIVE 600284790



Maruti Suzuki New Swift (2011-2017) Diesel



Schaeffler Part No.	Product Description and Position	Shock Absorber Type	MOQ	List	MRP	Picture
8090064100#E	Strut Assy. (FRH)	Full Assembly - Gas	4	3,411	4,447	
8090065100#E	Strut Assy. (FLH)	Full Assembly - Gas	4	3,411	4,447	
8090067100#E	Element (FRH)	Damper - Gas	4	1,539	1,996	
8090068100#E	Element (FLH)	Damper - Gas	4	1,539	1,996	

SALASAR AUTOMOTIVE 6002847900



Maruti Suzuki Swift (2005-2011) Petrol/Diesel



Schaeffler Part No.	Product Description and Position	Shock Absorber Type	MOQ	List	MRP	Picture
8090052100#E	Shock Assy. RLH/RRH	Damper - Gas	12	1,355	1,757	

SALASAR AUTOMOTIVE 6002847900



Maruti Suzuki Swift (2011-17) Petrol/Diesel







Schaeffler Part No.	Product Description and Position	Shock Absorber Type	MOQ	List	MRP	Picture
8090066100#E	Shock Assy. RLH/RRH	Damper - Gas	6	1,476	1,914	

SALASAR AUTOMOTIVE 6002847900



Maruti Suzuki New Swift & Swift Dzire (2017-Now) Diesel







Schaeffler Part No.	Product Description and Position	Shock Absorber Type	MOQ	List	MRP	Picture
8090190100#E	Strut Assy. (FRH)	Full Assembly - Gas	4	3,482	4,516	
8090191100#E	Strut Assy. (FLH)	Full Assembly - Gas	4	3,482	4,516	
8090209100#E	Element (FRH)	Damper - Gas	4	Introducing Soon		
8090210100#E	Element (FLH)	Damper - Gas	4	Introducing Soon		

SALASAR AUTOMOTIVE 6002847300



Maruti Suzuki Wagon-R (2000-2006) Petrol



Schaeffler Part No.	Product Description and Position	Shock Absorber Type	MOQ	List	MRP	Picture
8090078100#E	Strut Assy. (FLH)	Full Assembly - Gas	4	2,353	3,052	
8090079100#E	Strut Assy. (FRH)	Full Assembly - Gas	4	2,353	3,052	
8090080100#E	Element (FLH)	Damper - Gas	4	1,520	1,971	
8090081100#E	Element (FRH)	Damper - Gas	4	1,520	1,971	
8090141100#E	Shock Assy. RLH/RRH	Damper - Gas	12	656	851	

SALASAR AUTOMOTIVE 600287980



Maruti Suzuki Wagon-R Type-IV (2010-2018) Petrol







Schaeffler Part No.	Product Description and Position	Shock Absorber Type	MOQ	List	MRP	Picture
8090142100#E	Shock Assy. RLH/RRH	Damper - Gas	12	798	1,035	
8090082100#E	Element (FRH)	Damper - Gas	4	1,444	1,873	
8090083100#E	Element (FLH)	Damper - Gas	4	1,444	1,873	
8090084100#E	Strut Assy. (FRH)	Full Assembly - Gas	4	2,492	3,233	
8090085100#E	Strut Assy. (FLH)	Full Assembly - Gas	4	2,492	3,233	



Maruti Suzuki Zen (1996-2006) Petrol/Diesel



Schaeffler Part No.	Product Description and Position	Shock Absorber Type	MOQ	List	MRP	Picture
8090086100#E	Strut Assy. (FLH)	Full Assembly - Oil			Introducing Soon	
8090088100#E	Strut Assy. (FRH)	Full Assembly - Oil			Introducing Soon	
8090087100#E	Element-BushKit FLH	Damper - Oil			Introducing Soon	
8090089100#E	Element-Bushkit FRH	Damper - Oil			Introducing Soon	

SALASAR AUTOMOTIVE 600284750



Maruti Suzuki Zen (1996-2006) Petrol



Schaeffler Part No.	Product Description and Position	Shock Absorber Type	MOQ	List	MRP	Picture
8090143100#E	Shock Assy. RLH/RRH	Damper - Gas	12	660	856	

SALASAR AUTOMOTIVE 6002847900



NISSAN

MODELS

NISSAN MICRA
(2010-NOW) PETROL/DIESEL 

NISSAN MICRA/ SUNNY/ SCALA/
PULSE (2010-NOW) PETROL/DIESEL 

NISSAN MICRA
(2010-NOW) PETROL 

SALASAR AUTOMOTIVE 600247900



Nissan Micra (2010-Now) Petrol/Diesel





Schaeffler Part No.	Product Description and Position	Shock Absorber Type	MOQ	List	MRP	Picture
8090029100#E	Rear Shock LH/RH	Damper - Gas	6	1,213	1,573	

SALASAR AUTOMOTIVE 6002847900



Nissan Micra/ Sunny/ Scala/ Pulse (2010-Now) Petrol/Diesel





Schaeffler Part No.	Product Description and Position	Shock Absorber Type	MOQ	List	MRP	Picture
8090030100#E	Element (FLH)	Damper - Gas	4	1,895	2,458	
8090031100#E	Element (FRH)	Damper - Gas	4	1,895	2,458	

SALASAR AUTOMOTIVE 6002847900



Nissan Micra (2010-Now) Petrol



Schaeffler Part No.	Product Description and Position	Shock Absorber Type	MOQ	List	MRP	Picture
8090032100#E	Strut Assy. (FRH)	Full Assembly - Gas				
8090033100#E	Strut Assy. (FLH)	Full Assembly - Gas				

SALASAR AUTOMOTIVE 6002847900



RENAULT

MODELS

RENAULT DUSTER
(2012-NOW) PETROL/DIESEL



RENAULT KWID
(2015-2019) PETROL





SALASAR AUTOMOTIVE 6002547900



Renault Duster (2012-Now) Petrol/Diesel





Schaeffler Part No.	Product Description and Position	Shock Absorber Type	MOQ	List	MRP	Picture
8090034100#E	Shock Assy. RLH/RRH	Damper - Gas	6	2,048	2,656	
8090035100#E	Element (FLH/FRH)	Damper - Gas	4	2,266	2,939	

SALASAR AUTOMOTIVE 6002847900



Renault Kwid (2015-2019) Petrol



Schaeffler Part No.	Product Description and Position	Shock Absorber Type	MOQ	List	MRP	Picture
8090188100#E	Rear Shock LH/RH	Damper - Gas	6	1,032	1,339	
8090189100#E	Element (FLH/FRH)	Damper - Gas	4	1,310	1,699	



SALASAR AUTOMOTIVE 6002847900

TATA

MODELS

TATA ACE
(2005-2021) DIESEL



TATA INDICA
(2014-2019) DIESEL



TATA SUPER ACE
(2009-NOW) DIESEL



TATA ZEST/BOLT
(2014-2019) PETROL/DIESEL





SALASAR AUTOMOTIVE 002847900



Tata Ace (2005-2021) Diesel



Schaeffler Part No.	Product Description and Position	Shock Absorber Type	MOQ	List	MRP	Picture
8090017100#E	Shock Assy.-FRH/FLH	Oil	12	874	1,134	
8090018100#E	Shock Assy. RLH/RRH	Damper - Oil	12	862	1,118	

SALASAR AUTOMOTIVE 6002847500



Tata Indica (2014-2019) Diesel



Schaeffler Part No.	Product Description and Position	Shock Absorber Type	MOQ	List	MRP	Picture
8090013100#E	Strut Assy. (FLH)	Full Assembly - Gas	2	3,801	4,930	
8090014100#E	Strut Assy. (FRH)	Full Assembly - Gas	2	3,801	4,930	
8090015100#E	Rear Shock LH	Full Assembly - Gas	4	1,985	2,575	
8090016100#E	Rear Shock RH	Full Assembly - Gas	4	1,985	2,575	
8090204100#E	Element (FLH)	Damper - Gas	4	1,907	2,484	
8090205100#E	Element (FRH)	Damper - Gas	4	1,907	2,484	
8090206100#E	Element (RLH/RRH)	Damper - Gas	4	1,200	1,564	



Tata Super Ace (2009-Now) Diesel



Schaeffler Part No.	Product Description and Position	Shock Absorber Type	MOQ	List	MRP	Picture
8090019100#E	Shock Assy. RLH/RRH	Damper - Oil	12	938	1,217	
8090020100#E	Element (FLH)	Damper - Gas	4	2,773	3,597	
8090021100#E	Element (FRH)	Damper - Gas	4	2,773	3,597	
8090022100#E	Strut Assy. (FLH)	Full Assembly - Gas	2	3,216	4,171	
8090023100#E	Strut Assy. (FRH)	Full Assembly - Gas	2	3,216	4,171	

SALASAR AUTOMOTIVE 600284790



Tata Zest/Bolt (2014-2019) Petrol/Diesel



Schaeffler Part No.	Product Description and Position	Shock Absorber Type	MOQ	List	MRP	Picture
8090010100#E	Shock Assy. RLH/RRH	Damper - Gas	6	2,037	2,642	
8090011100#E	Strut Assy. (FLH)	Full Assembly - Gas	2	4,109	5,329	
8090012100#E	Strut Assy. (FRH)	Full Assembly - Gas	2	4,109	5,329	
8090202100#E	Element (FLH)	Damper - Gas	4	2,201	2,867	
8090203100#E	Element (FRH)	Damper - Gas	4	2,201	2,867	

SALASAR AUTOMOTIVE 6002847900



TEMPO TRAVELLER

MODELS

TEMPO TRAVELLER
(2000 - NOW) DIESEL





SALASAR AUTOMOTIVE 6002847900



Tempo Traveller (2000 - Now) Diesel



Schaeffler Part No.	Product Description and Position	Shock Absorber Type	MOQ	List	MRP	Picture
8090048100#E	Strut Assy. FRH/FLH	Oil				
8090049100#E	Shock Assy. RLH/RRH	Damper - Oil				

SALASAR AUTOMOTIVE 6002847900



TOYOTA

MODELS

TOYOTA ETIOS/LIVA
(2010-2020) PETROL/DIESEL



TOYOTA INNOVA
(2005-2016) DIESEL



TOYOTA QUALIS
(1999-2004) PETROL/DIESEL



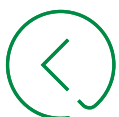

SALASAR AUTOMOTIVE 6002547900



Toyota Etios/Liva (2010-2020) Petrol/Diesel



Schaeffler Part No.	Product Description and Position	Shock Absorber Type	MOQ	List	MRP	Picture
8090036100#E	Rear Shock LH/RH	Damper - Gas	6	1,240	1,608	
8090037100#E	Element (FLH/FRH)	Damper - Gas	4	1,862	2,415	
8090038100#E	Strut Assy. FRH/FLH	Full Assembly - Gas	2	3,668	4,758	

SALASAR AUTOMOTIVE 6002847900



Toyota Innova (2005-2016) Diesel





Schaeffler Part No.	Product Description and Position	Shock Absorber Type	MOQ	List	MRP	Picture
8090039100#E	Shock Assy. RLH/RRH	Damper - Gas	6	1,065	1,381	
8090040100#E	Strut Assy. (FLH)	Full Assembly - Gas	2	3,660	4,747	
8090041100#E	Strut Assy. (FRH)	Full Assembly - Gas	2	3,660	4,747	

SALASAR AUTOMOTIVE 6002847900



Toyota Qualis (1999-2004) Petrol/Diesel



Schaeffler Part No.	Product Description and Position	Shock Absorber Type	MOQ	List	MRP	Picture
8090008100#E	Shock Assy.-FRH/FLH	Oil			Introducing Soon	
8090009100#E	Shock Assy. RLH/RRH	Damper - Oil			Introducing Soon	

SALASAR AUTOMOTIVE 6002247900



VOLKSWAGEN

MODELS



Volkswagen Polo/Vento/Fabia/
Rapid (2009-2015) Petrol/Diesel 

SALASAR AUTOMOTIVE 6002847900



Volkswagen Polo/Vento/Fabia/Rapid (2009-2015) Petrol/Diesel



Schaeffler Part No.	Product Description and Position	Shock Absorber Type	MOQ	List	MRP	Picture
8090042100#E	Rear Shock LH/RH	Damper - Gas	6	1,547	2,006	
8090043100#E	Element (FLH/FRH)	Damper - Gas	4	1,968	2,552	

SALASAR AUTOMOTIVE 6002847900



SCHAEFFLER



REGD. OFFICE
Schaeffler India Limited
15th Floor, Amar Sadanand Tech Park,
Plot No. 3, Survey No. 105/3 104/1,
Baner, Pune - 411045,
Maharashtra, India
+91 20 68198400

AUTOMOTIVE AFTERMARKET OFFICE
Schaeffler India Limited
1401-1403, Kesar Solitaire,
Plot No.5, Sector 19, Palm Beach Road,
Sanpada, Navi Mumbai - 400705,
Maharashtra, India
+91 22 61791601

